

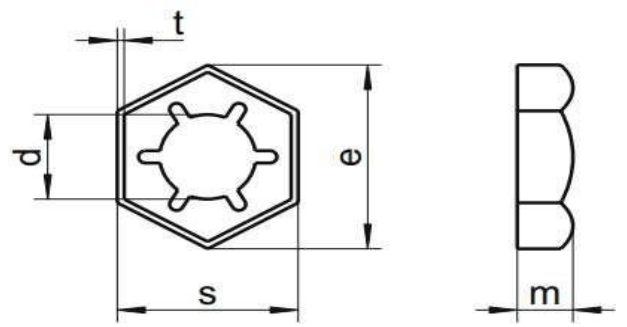

W7FS4

AISI 316



DIN 7967 PAL NUT
Self Locking Counter Nut

Quote the item code given below with your order/enquiries.

Dimensions in mm

Thread Size	Item Code	Inside diameter	Nut Height	Across Flat	Across Corners	thickness	
d	PART NUMBER	d	m	s max	s min	e	t
M4x0.7	W7FS404000	3.50	2.50	7.00	6.64	8.10	0.30
M5x0.8	W7FS405000	4.50	2.50	8.00	7.64	9.20	0.40
M6x1.0	W7FS406000	5.30	3.00	10.00	8.64	11.50	0.40
M8x1.0	W7FS408000	6.90	3.50	13.00	12.57	15.00	0.50
M10x1.5	W7FS410000	8.60	4.00	17.00	16.57	19.60	0.50
M12x1.75	W7FS412000	10.40	4.50	19.00	18.48	21.90	0.60
M14x2.0	W7FS414000	12.00	5.00	22.00	21.16	25.40	0.60
M16x2.0	W7FS416000	14.10	5.00	24.00	23.16	27.70	0.70
M18x2.5	W7FS418000	15.50	5.50	27.00	26.16	31.20	0.70
M20x2.5	W7FS420000	17.60	6.00	30.00	29.16	34.60	0.80
M22x2.5	W7FS422000	19.60	6.00	32.00	33.00	36.90	0.80
M24x3.0	W7FS424000	21.00	7.00	36.00	35.00	41.60	0.90

Sizes in BROWN are non-preferred. Availability is limited and MOQ is higher.

Data is strictly informative

Note: All Austenitic Stainless Steel Fasteners may exhibit some magnetic properties due to the manufacturing process.

Refer: ISO 3506-2 Annex F